

# BRFL15N65

Rev.E Nov.-2017

## 描述 / Descriptions

TO-220FL 塑封封装 N 沟道 MOS 场效应管。N-CHANNEL MOSFET in a TO-220FL Plastic Package.

## 特征 / Features

低栅极电荷，低 Crss，快速开关，100%的雪崩测试，改进 dv/dt 能力。

Low gate charge, Low Crss, Fast switching, 100% avalanche tested, Improved dv/dt capability.

## 用途 / Applications

适合高效率的开关式电源供应器和有源功率因数校正。

These devices are well suited for high efficient switched mode power supplies and active power factor correction .

## 内部等效电路 / Equivalent Circuit

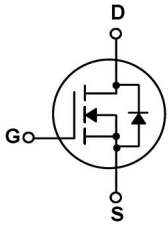

## 引脚排列 / Pinning

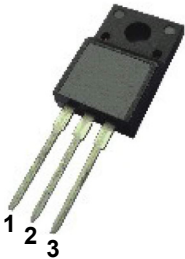

PIN 1 : G

PIN 2 : D

PIN 3 : S

## 放大及印章代码 / h<sub>FE</sub> Classifications & Marking

见印章说明。See Marking Instructions.

**极限参数 / Absolute Maximum Ratings(Ta=25°C)**

参数 Parameter	符号 Symbol	数值 Rating	单位 Unit
Drain-Source Voltage	$V_{DSS}$	650	V
Drain Current	$I_D(T_c=25^\circ\text{C})$	15	A
Drain Current	$I_D(T_c=100^\circ\text{C})$	9.5	A
Drain Current - Pulsed	$I_{DM}$	60	A
Gate-Source Voltage	$V_{GSS}$	±30	V
Single Pulsed Avalanche Energy	$E_{AS}$	637	mJ
Repetitive Avalanche Energy	$E_{AR}$	25	mJ
Avalanche Current	$I_{AR}$	15	A
Power Dissipation	$P_D(T_c=25^\circ\text{C})$	73.5	W
Operating and Storage Temperature Range	$T_J, T_{STG}$	-55 to 150	°C

**电性能参数 / Electrical Characteristics(Ta=25°C)**

参数 Parameter	符号 Symbol	测试条件 Test Conditions	最小值 Min	典型值 Typ	最大值 Max	单位 Unit
Drain-Source Breakdown Voltage	$BV_{DSS}$	$V_{GS}=0V$ $I_D=250\mu A$	650			V
Zero Gate Voltage Drain Current	$I_{DSS}$	$V_{DS}=650V$ $V_{GS}=0V$			1.0	$\mu A$
		$V_{DS}=520V$ $T_c=125^\circ\text{C}$			10	$\mu A$
Gate-Body Leakage Current Forward	$I_{GSS}$	$V_{GS}=\pm 30V$ $V_{DS}=0V$			±100	nA
Gate Threshold Voltage	$V_{GS(th)}$	$V_{DS}=V_{GS}$ $I_D=250\mu A$	3.0		5.0	V
Static Drain-Source On-Resistance	$R_{DS(on)}$	$V_{GS}=10V$ $I_D=7.5A$		0.36	0.44	$\Omega$
Forward Transconductance	$g_{FS}$	$V_{DS}=40V$ $I_D=7.5A$		19.2		S
Drain-Source Diode Forward Voltage	$V_{SD}$	$V_{GS}=0V$ $I_S=15A$			1.4	V
Input Capacitance	$C_{iss}$	$V_{DS}=25V$ $V_{GS}=0V$ $f=1.0\text{MHz}$		2380	3095	pF
Output Capacitance	$C_{oss}$			295	385	pF
Reverse Transfer Capacitance	$C_{rss}$			23.6	35.5	pF
Turn-On Delay Time	$t_{d(on)}$	$V_{DD}=325V$ $I_D=15A$ $R_G=21.7\Omega$		65	140	ns
Turn-On Rise Time	$t_r$			125	260	ns
Turn-Off Delay Time	$t_{d(off)}$			105	220	ns
Turn-Off Fall Time	$t_f$			65	140	ns

**电参数曲线图 / Electrical Characteristic Curve**

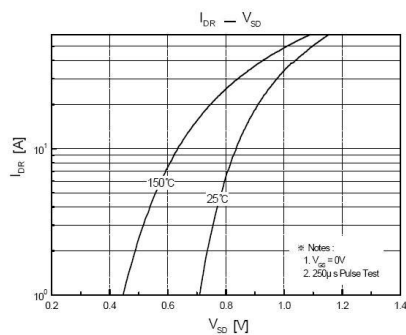
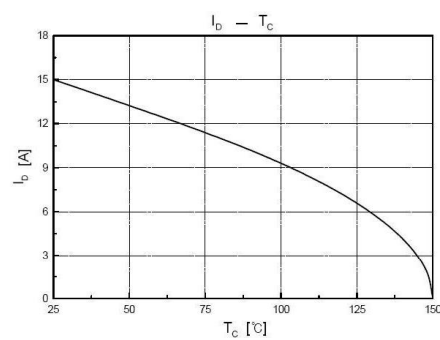
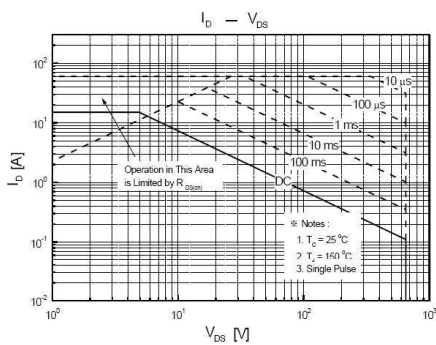
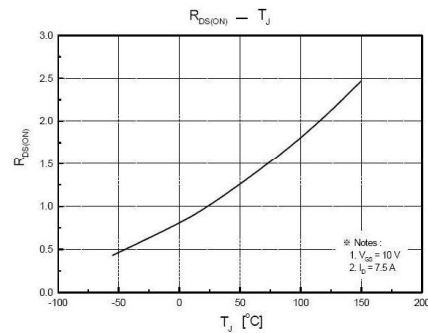
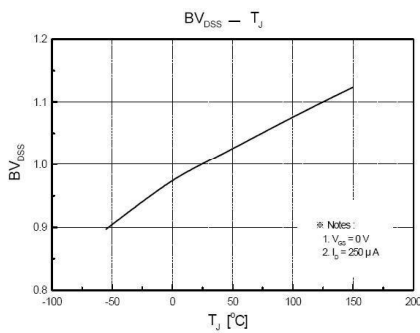
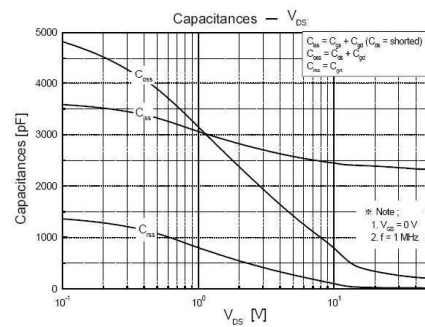
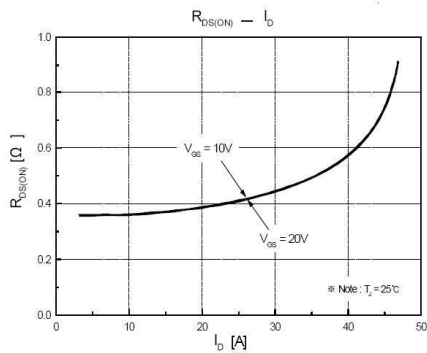
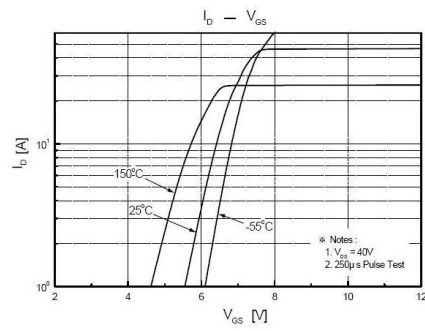
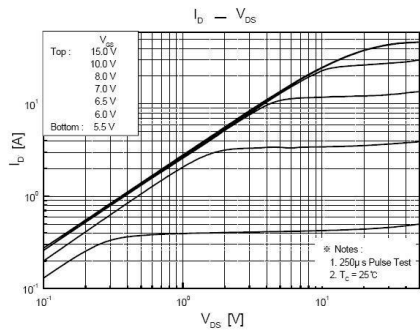

外形尺寸图 / Package Dimensions

TO-220FL

单位: mm

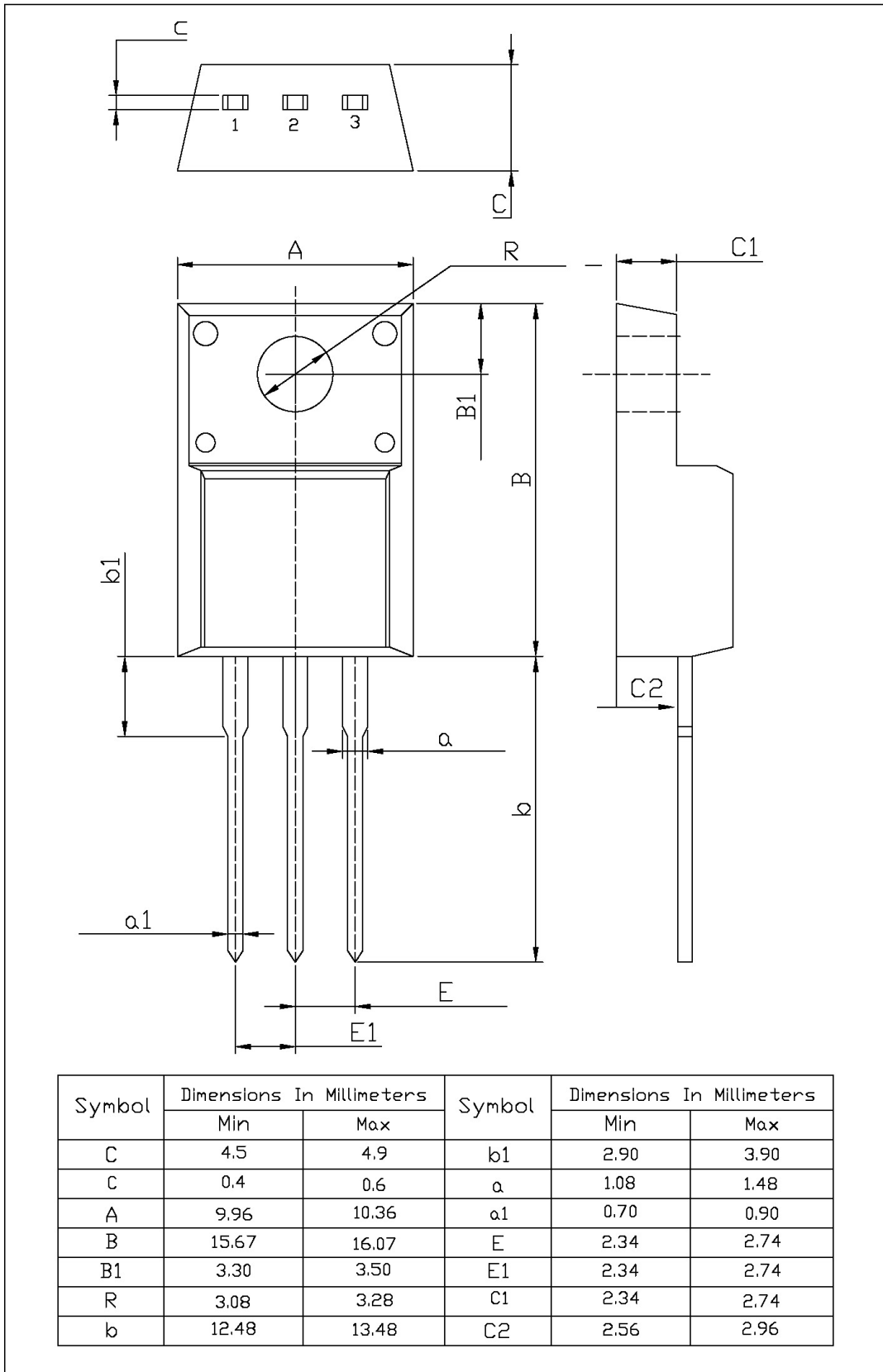

印章说明 / Marking Instructions

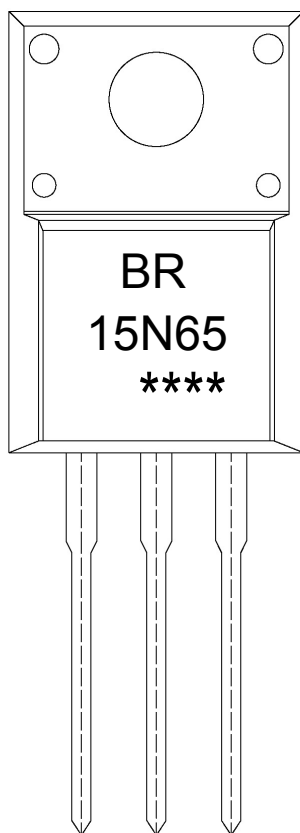

说明：

BR： 为公司代码

15N65： 为型号代码

\*\*\*\*： 为生产批号代码，随生产批号变化。

Note:

BR: Company Code

15N65: Product Type.

\*\*\*\*: Lot No. Code, code change with Lot No.

**波峰焊温度曲线图(无铅) / Temperature Profile for Dip Soldering(Pb-Free)**

说明：

- 1、预热温度 25 ~ 150°C，时间 60 ~ 90sec;
- 2、峰值温度 255±5°C，时间持续为 5±0.5sec;
- 3、焊接制程冷却速度为 2 ~ 10°C/sec.

Note:

- 1.Preheating:25~150°C, Time:60~90sec.
- 2.Peak Temp.:255±5°C, Duration:5±0.5sec.
3. Cooling Speed: 2~10°C/sec.

**耐焊接热试验条件 / Resistance to Soldering Heat Test Conditions**

温度：270±5°C

时间：10±1 sec.

Temp.:270±5°C

Time:10±1 sec

**包装规格 / Packaging SPEC.**

套管包装 / TUBE

Package Type 封装形式	Units 包装数量					Dimension 包装尺寸 (unit: mm <sup>3</sup> )		
	Units/Tube 只/套管	Tubes/Inner Box 套管/盒	Units/Inner Box 只/盒	Inner Boxes/Outer Box 盒/箱	Units/Outer Box 只/箱	Tube 套管	Inner Box 盒	Outer Box 箱
TO-220FL	50	20	1,000	5	5,000	532×33×7.0	555×164×50	575×290×180

**使用说明 / Notices**