

# BRCS900P10DP

Rev.A Aug.-2023

## 描述 / Descriptions

TO-252 塑封封装 P 沟道 MOS 场效应管。  
P-CHANNEL MOSFET in a TO-252 Plastic Package.

## 特征 / Features

$V_{DS}(V)=-100V$      $I_D=-18A$   
 $R_{DS(ON)}@-10V<90m\Omega$ (Typ.80mR)  
 $R_{DS(ON)}@-4.5V<100m\Omega$ (Typ.90mR)  
无卤产品。 HF Product.

## 用途 / Applications

工业级DC/DC转换器的电源管理  
Power Management of Industrial DC/DC Converter.

## 内部等效电路 / Equivalent Circuit

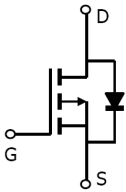

## 引脚排列 / Pinning

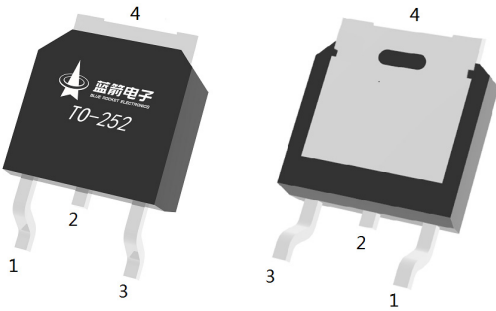

PIN 1 : G

PIN 2 : D

PIN 3 : S

PIN 4 : D

## 印章代码 / Marking

见印章说明。  
See Marking Instructions.

**极限参数 / Absolute Maximum Ratings(T<sub>a</sub>=25°C)**

参数 Parameter		符号 Symbol	数值 Rating	单位 Unit
Drain-Source Voltage		V <sub>DS</sub>	-100	V
Drain Current - Continuous		I <sub>D</sub> (T <sub>c</sub> =25°C)	-18	A
Drain Current – Pulsed		I <sub>DM</sub>	-54	A
Gate-Source Voltage		V <sub>GS</sub>	±20	V
Power Dissipation		P <sub>D</sub> (T <sub>c</sub> =25°C)	65	W
Single Pulse Avalanche Energy(L=0.5mH)		E <sub>AS</sub>	185	mJ
Avalanche Current(L=0.5mH)		I <sub>AS</sub>	-21.5	A
Junction and Storage Temperature Range		T <sub>j</sub> , T <sub>stg</sub>	-55 to 150	°C
Thermal resistance, junction - ambient	Steady-State	R <sub>θJA</sub>	63	°C/W
Thermal resistance, junction - case	Steady-State	R <sub>θJC</sub>	1.92	

**电性能参数 / Electrical Characteristics(T<sub>a</sub>=25°C)**

参数 Parameter	符号 Symbol	测试条件 Test Conditions	最小值 Min	典型值 Typ	最大值 Max	单位 Unit
Drain-Source Breakdown Voltage	BV <sub>DSS</sub>	I <sub>D</sub> =-250μA V <sub>GS</sub> =0V	-100	-110		V
Zero Gate Voltage Drain Current	I <sub>DSS</sub>	V <sub>DS</sub> =-100V V <sub>GS</sub> =0V			-1	uA
Gate-Body leakage current	I <sub>GSS</sub>	V <sub>DS</sub> =0V, V <sub>GS</sub> =±20V			±100	nA
Gate Threshold Voltage	V <sub>GS(th)</sub>	V <sub>DS</sub> =V <sub>GS</sub> I <sub>D</sub> =-250μA	-1	-1.7	-2.5	V
Static Drain-Source On-Resistance	R <sub>DS(ON)</sub>	V <sub>GS</sub> =-10V, I <sub>D</sub> =-10A		80	90	mΩ
		V <sub>GS</sub> =-4.5V, I <sub>D</sub> =-10A		90	100	
Diode Forward Voltage	V <sub>SD</sub>	I <sub>S</sub> =-1A, V <sub>GS</sub> =0V			-1.2	V
Input Capacitance	C <sub>iss</sub>	V <sub>DS</sub> =-15V V <sub>GS</sub> =0V f=1.0MHz		5200		pF
Output Capacitance	C <sub>oss</sub>			750		
Reverse Transfer Capacitance	C <sub>rss</sub>			450		
Gate resistance	R <sub>g</sub>	V <sub>GS</sub> =0V V <sub>DS</sub> =0V f=1MHz		4.2		Ω
Total Gate Charge	Q <sub>g(10V)</sub>	V <sub>GS</sub> =-10V, V <sub>DS</sub> =-50V, I <sub>D</sub> =-5A		5.9		nC
Total Gate Charge	Q <sub>g(4.5V)</sub>			2.7		
Gate Source Charge	Q <sub>gs</sub>			1.2		
Gate Drain Charge	Q <sub>gd</sub>			1.2		

## 电性能参数 / Electrical Characteristics(Ta=25°C)

参数 Parameter	符号 Symbol	测试条件 Test Conditions	最小值 Min	典型值 Typ	最大值 Max	单位 Unit
Turn-On Delay Time	$t_{d(on)}$	$V_{GS}=-10V$ $V_{DS}=-50V$ $R_L=10\ \Omega$ $R_{GEN}=3\ \Omega$		6		ns
Turn-On Rise Time	$t_r$			2.4		
Turn-Off Delay Time	$t_{d(off)}$			19		
Turn-Off Fall Time	$t_f$			2.6		

电参数曲线图 / Electrical Characteristic Curve

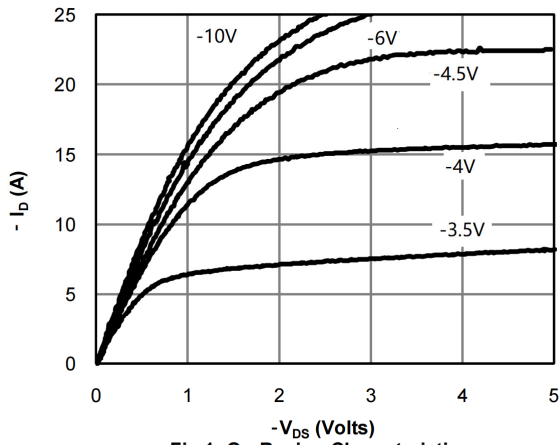

Fig 1: On-Region Characteristics

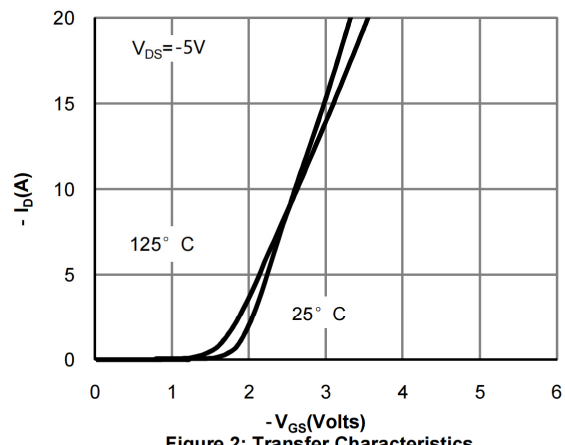

Figure 2: Transfer Characteristics

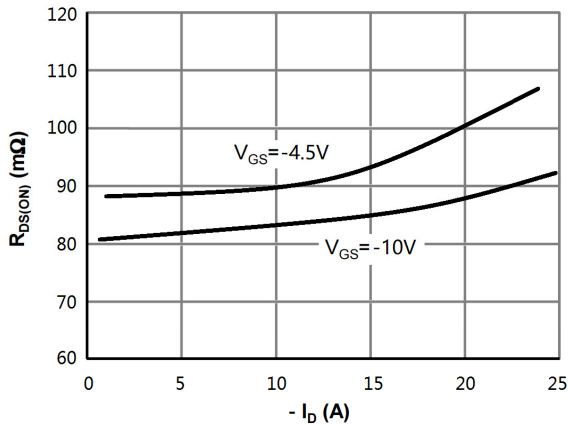

Figure 3: On-Resistance vs. Drain Current and Gate Voltage

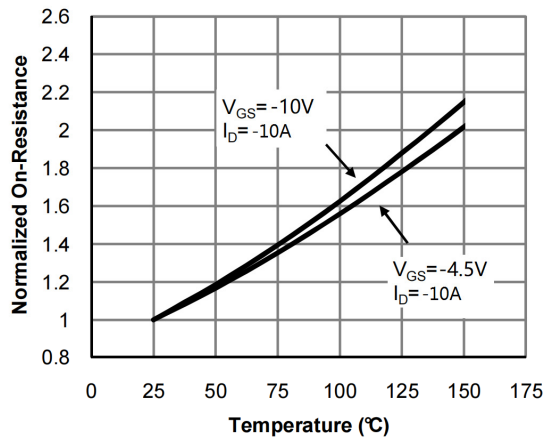

Figure 4: On-Resistance vs. Junction Temperature

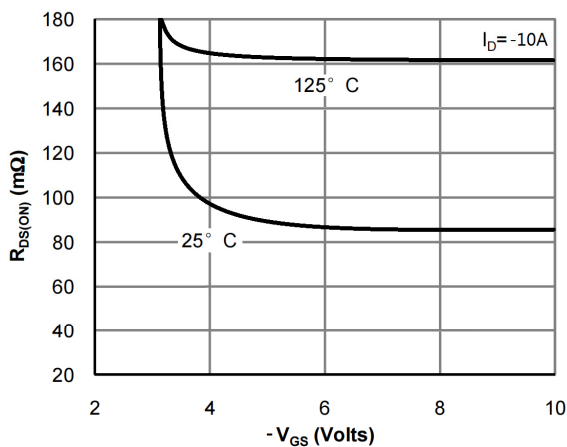

Figure 5: On-Resistance vs. Gate-Source Voltage

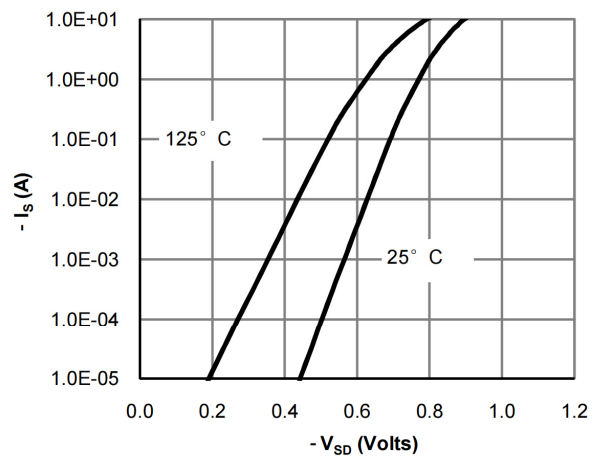

Figure 6: Body-Diode Characteristics

电参数曲线图 / Electrical Characteristic Curve

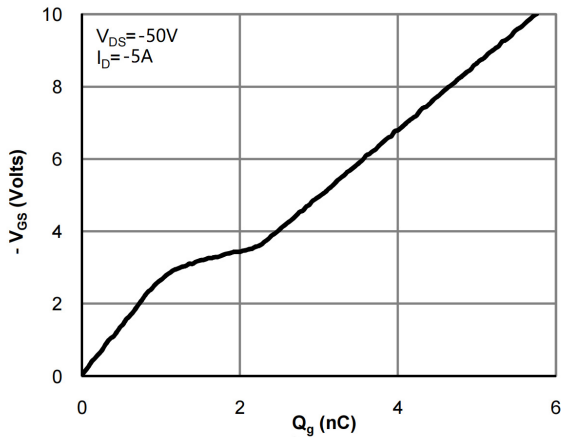

Figure 7: Gate-Charge Characteristics

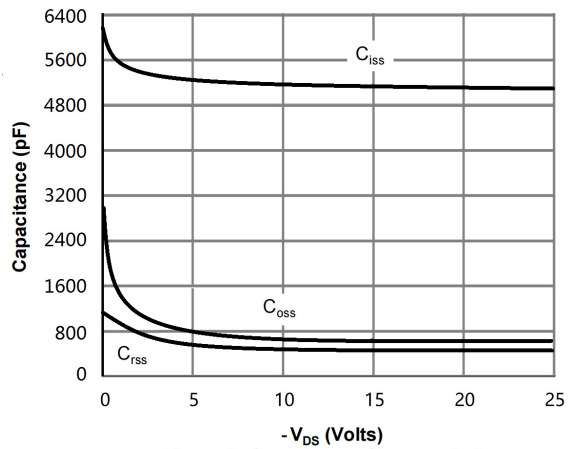

Figure 8: Capacitance Characteristics

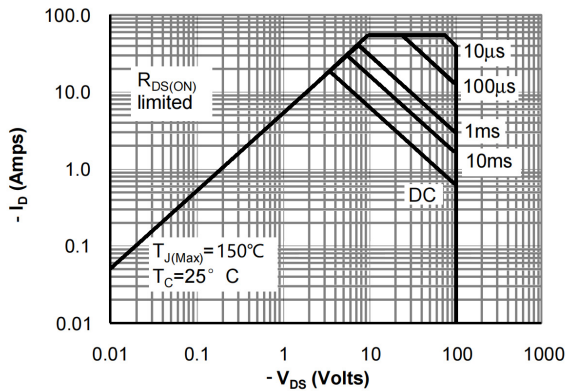

Figure 9: Maximum Forward Biased Safe Operating Area

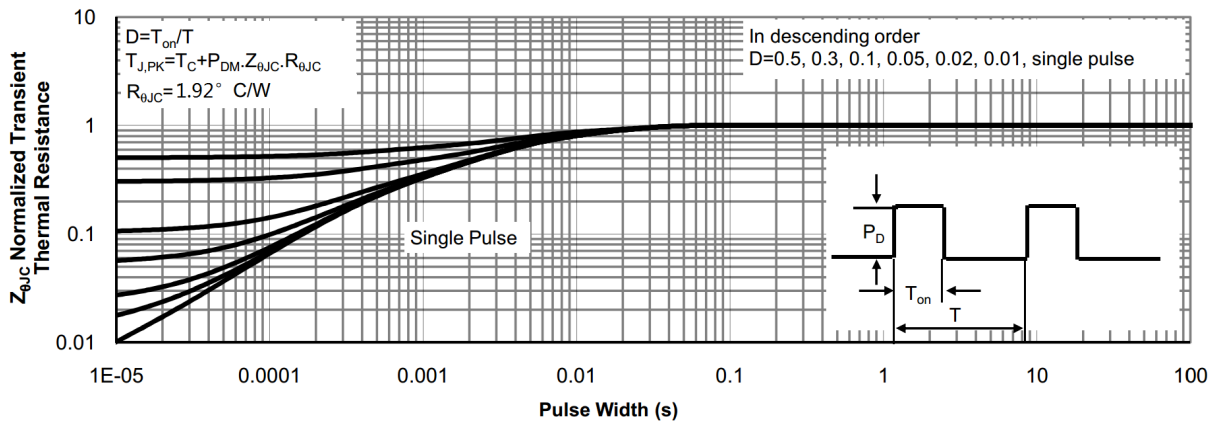
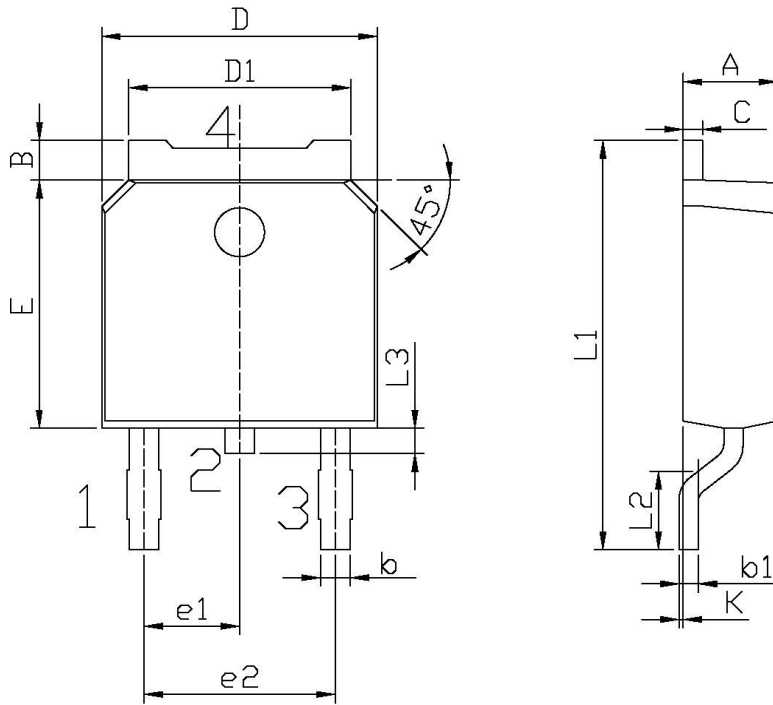

Figure 10: Normalized Maximum Transient Thermal Impedance

**外形尺寸图 / Package Dimensions**



单位: mm

Symbol	Dimensions In Millimeters		Symbol	Dimensions In Millimeters	
	Min	Max		Min	Max
A	2.20	2.40	E	5.95	6.25
B	0.95	1.25	e1	2.24	2.34
b	0.70	0.90	e2	4.43	4.73
b1	0.45	0.55	L1	9.85	10.35
C	0.45	0.55	L2	1.70	2.00
D	6.45	6.75	L3	0.60	0.90
D1	5.10	5.50	K	0.00	0.10

TO-252

## 印章说明 / Marking Instructions

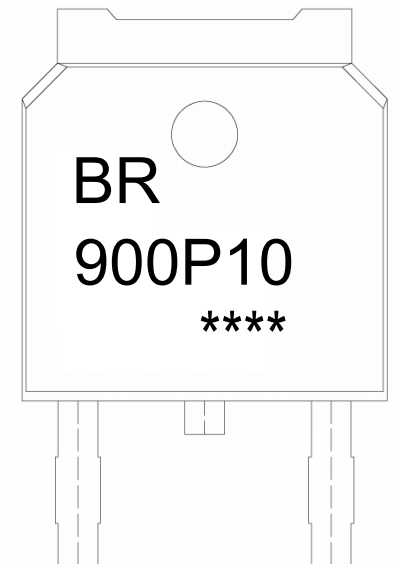

说明：

BR： 为公司代码

900P10： 为产品型号

\*\*\*\*： 为生产批号代码，随生产批号变化

Note:

BR: Company Code

900P10: Product Type

\*\*\*\*: Lot No. Code, code change with Lot No

**回流焊温度曲线图(无铅) / Temperature Profile for IR Reflow Soldering(Pb-Free)**

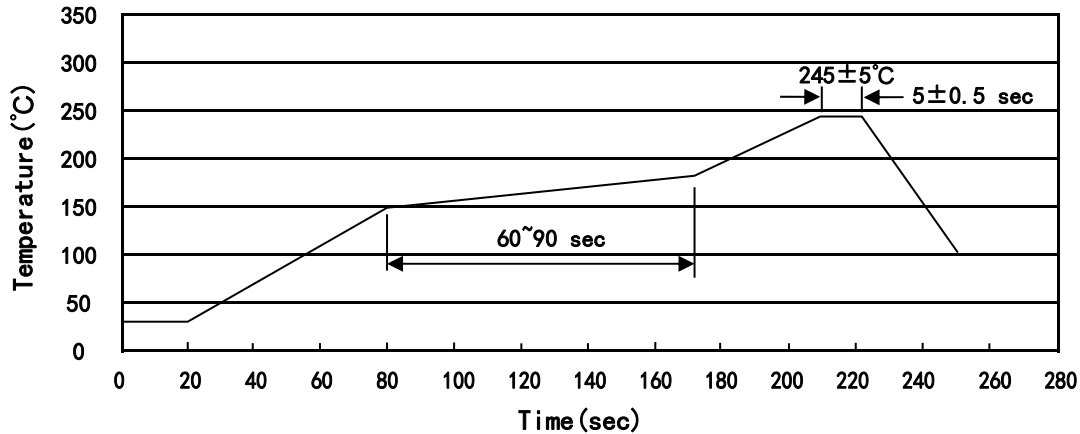

说明：

- 1、预热温度 150~180°C，时间 60~90sec;
- 2、峰值温度 245±5°C，时间持续为 5±0.5sec;
- 3、焊接制程冷却速度为 2~10°C/sec.

Note:

- 1.Preheating:150~180°C, Time:60~90sec.
- 2.Peak Temp.:245±5°C, Duration:5±0.5sec.
3. Cooling Speed: 2~10°C/sec.

**耐焊接热试验条件 / Resistance to Soldering Heat Test Conditions**

温度：260±5°C

时间：10±1 sec.

Temp.:260±5°C

Time:10±1 sec

**包装规格 / Packaging SPEC.**

卷盘包装 / REEL

Package Type 封装形式	Units 包装数量					Dimension 包装尺寸 (unit: mm <sup>3</sup> )		
	Units/Reel 只/卷盘	Reels/Inner Box 卷盘/盒	Units/Inner Box 只/盒	Inner Boxes/Outer Box 盒/箱	Units/Outer Box 只/箱	Reel	Inner Box 盒	Outer Box 箱
TO-252	2,500	2	5,000	6	30,000	13" ×16	360×360×50	380×335×366

套管包装 / TUBE

Package Type 封装形式	Units 包装数量					Dimension 包装尺寸 (unit: mm <sup>3</sup> )		
	Units/Tube 只/套管	Tubes/Inner Box 套管/盒	Units/Inner Box 只/盒	Inner Boxes/Outer Box 盒/箱	Units/Outer Box 只/箱	Tube 套管	Inner Box 盒	Outer Box 箱
TO-251/252	75	48	3,600	5	18,000	526×20.5×5.25	555×164×50	575×290×180

**使用说明 / Notices**