

BRCS250N10SYMQ

Rev.A Mar.-2025

描述 / Descriptions

PDFN5×6A 塑封封装双 N 沟道场效应管。

Dual N-CHANNEL MOSFET in a PDFN5×6A Plastic Package.

特征 / Features

$V_{DS} (V) = 100V$ $I_D = 30A$ ($V_{GS} = \pm 20V$)

$R_{DS(ON)}@10V \leq 25mR$ (Typ. 20mR)

$R_{DS(ON)}@4.5V \leq 35mR$ (Typ. 25mR)

符合 AEC-Q101 标准高可靠性要求；无卤产品。

Qualified to AEC-Q101 Standards for High Reliability; HF Product.

用途 / Applications

DC/DC 转换器，适用于高频开关和同步整流，满足汽车应用的严格要求。

DC/DC Converter, Ideal for high-frequency switching and synchronous rectification, Meet the stringent requirements of automotive applications.

内部等效电路 / Equivalent Circuit

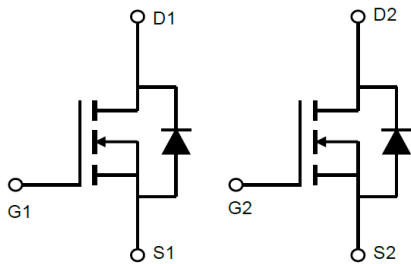

引脚排列 / Pinning

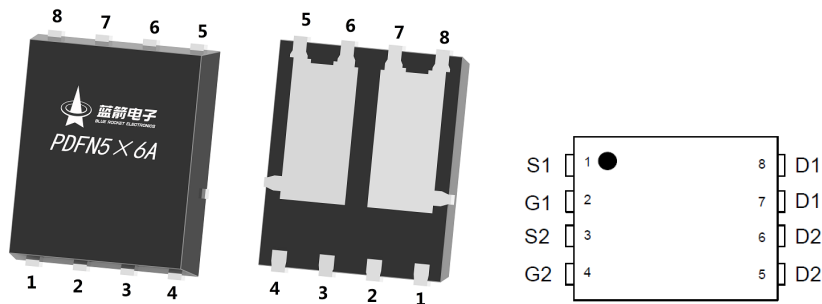

印章代码 / Marking

见印章说明。

See Marking Instructions.

极限参数 / Absolute Maximum Ratings(Ta=25°C)

参数 Parameter	符号 Symbol	数值 Rating	单位 Unit
Drain-Source Voltage	V _{DSS}	100	V
Drain Current	I _D (Tc=25°C)	30	A
Drain Current - Pulsed	I _{DM}	113	A
Gate-Source Voltage	V _{GS}	±20	V
Avalanche Current	I _{AS}	7	A
Single Pulsed Avalanche Energy	E _{AS}	24.5	mJ
Power Dissipation	P _D (Tc=25°C)	45	W
Storage Temperature Range	T _{stg}	-55~150	°C
Thermal Resistance-Junction to Ambient	t ≤ 10s	40	°C/W
	Steady-State	63	
Thermal Resistance-Junction to Case	Steady-State	2.78	

电性能参数 / Electrical Characteristics(Ta=25°C)

参数 Parameter	符号 Symbol	测试条件 Test Conditions	最小值 Min	典型值 Typ	最大值 Max	单位 Unit
Drain-Source Breakdown Voltage	BV _{DSS}	V _{GS} =0V I _D =250μA	100	109		V
Zero Gate Voltage Drain Current	I _{DSS}	V _{DS} =100V V _{GS} =0V			1	μA
Gate-Body Leakage Current Forward	I _{GSS}	V _{GS} =±20V V _{DS} =0V			±0.1	μA
Gate Threshold Voltage	V _{GS(th)}	V _{DS} =V _{GS} I _D =250μA	1.0	1.6	2.5	V
Static Drain-Source On-Resistance	R _{DS(on)}	V _{GS} =10V I _D =20A		20	25	mΩ
		V _{GS} =4.5V I _D =10A		25	35	mΩ
Drain-Source Diode Forward Voltage	V _{SD}	V _{GS} =0V I _S =1A			1.2	V
Input Capacitance	C _{iss}	V _{DS} =25V V _{GS} =0V f=1.0MHz		820		pF
Output Capacitance	C _{oss}			475		
Reverse Transfer Capacitance	C _{rss}			35		
Gate resistance	R _g	V _{GS} =0V V _{DS} =0V f=1MHz		1.9		Ω
Total Gate Charge	Q _{g(10V)}	V _{GS} =10V V _{DS} =50V I _D =9A		17		nC
Total Gate Charge	Q _{g(4.5V)}			9		
Gate Source Charge	Q _{gs}			3		
Gate Drain Charge	Q _{gd}			3.5		

电性能参数 / Electrical Characteristics(Ta=25°C)

参数 Parameter	符号 Symbol	测试条件 Test Conditions	最小值 Min	典型值 Typ	最大值 Max	单位 Unit
Turn-On Delay Time	$t_{d(on)}$	$V_{GS}=10V$ $V_{DS}=50V$ $R_L=5.5\Omega$ $R_{GEN}=3.0\Omega$		5		ns
Turn-On Rise Time	t_r			3.2		
Turn-Off Delay Time	$t_{d(off)}$			21		
Turn-Off Fall Time	t_f			3		

电参数曲线图 / Electrical Characteristic Curve

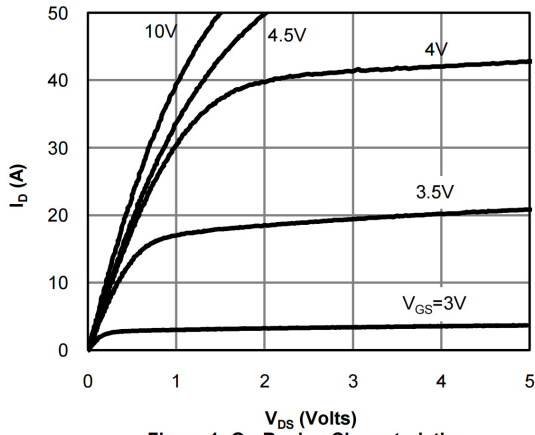

Figure 1: On-Region Characteristics

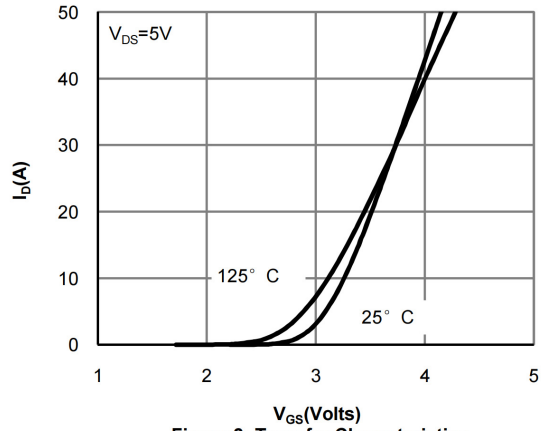

Figure 2: Transfer Characteristics

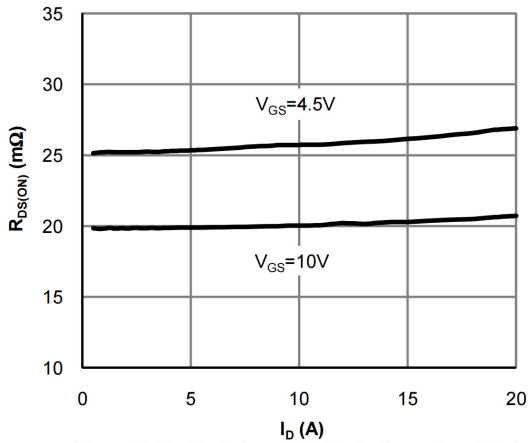

Figure 3: On-Resistance vs. Drain Current and Gate Voltage

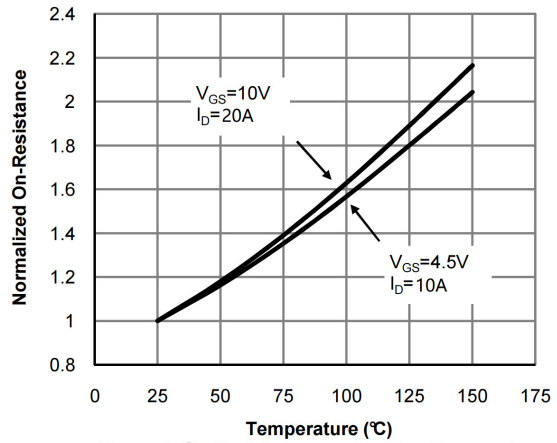

Figure 4: On-Resistance vs. Junction Temperature

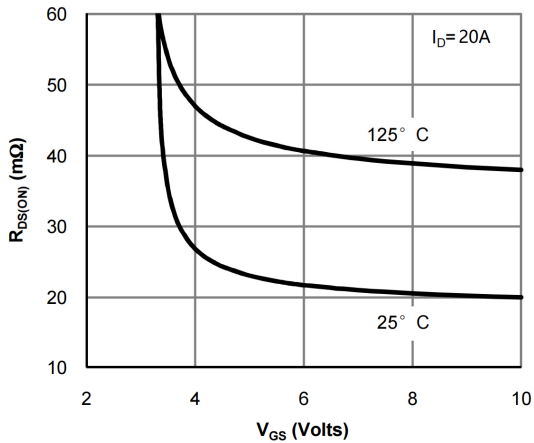

Figure 5: On-Resistance vs. Gate-Source Voltage

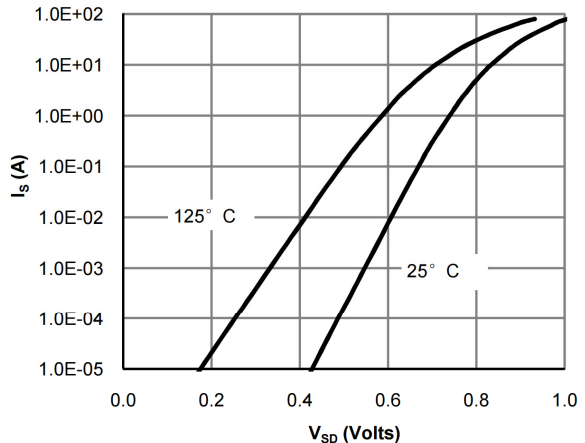

Figure 6: Body-Diode Characteristics

电参数曲线图 / Electrical Characteristic Curve

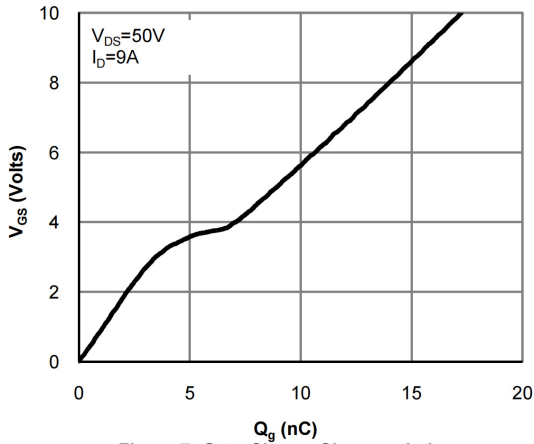

Figure 7: Gate-Charge Characteristics

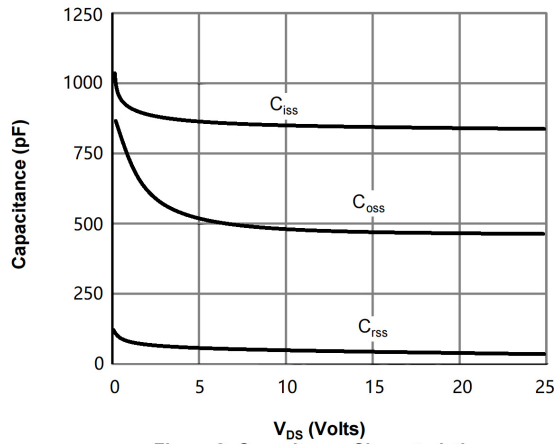

Figure 8: Capacitance Characteristics

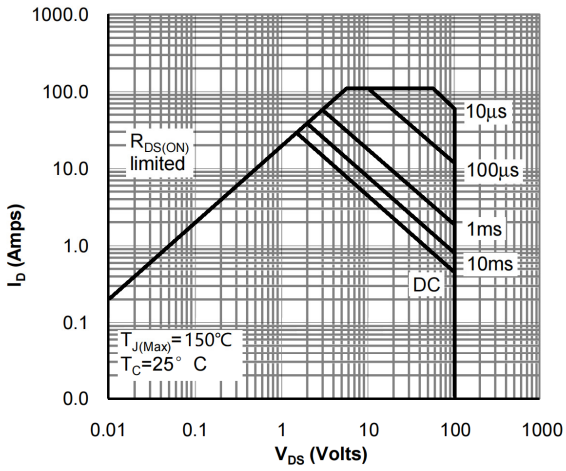

Figure 9: Maximum Forward Biased Safe Operating Area

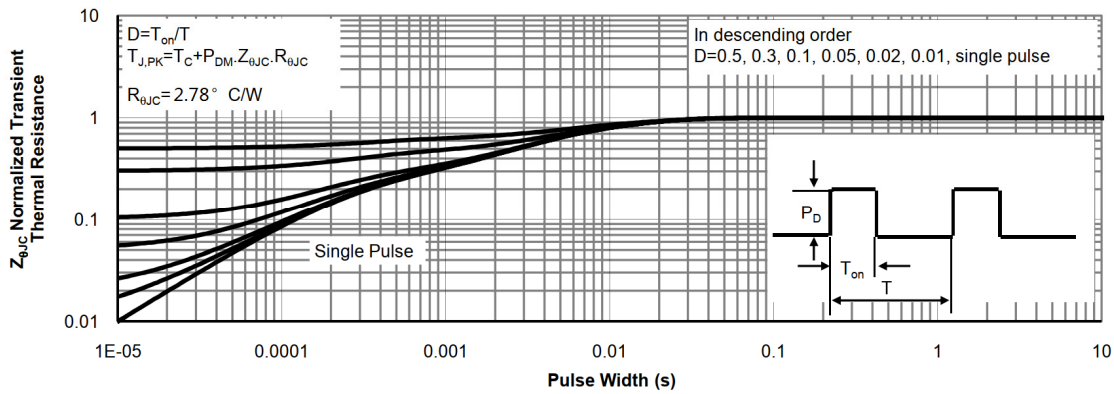
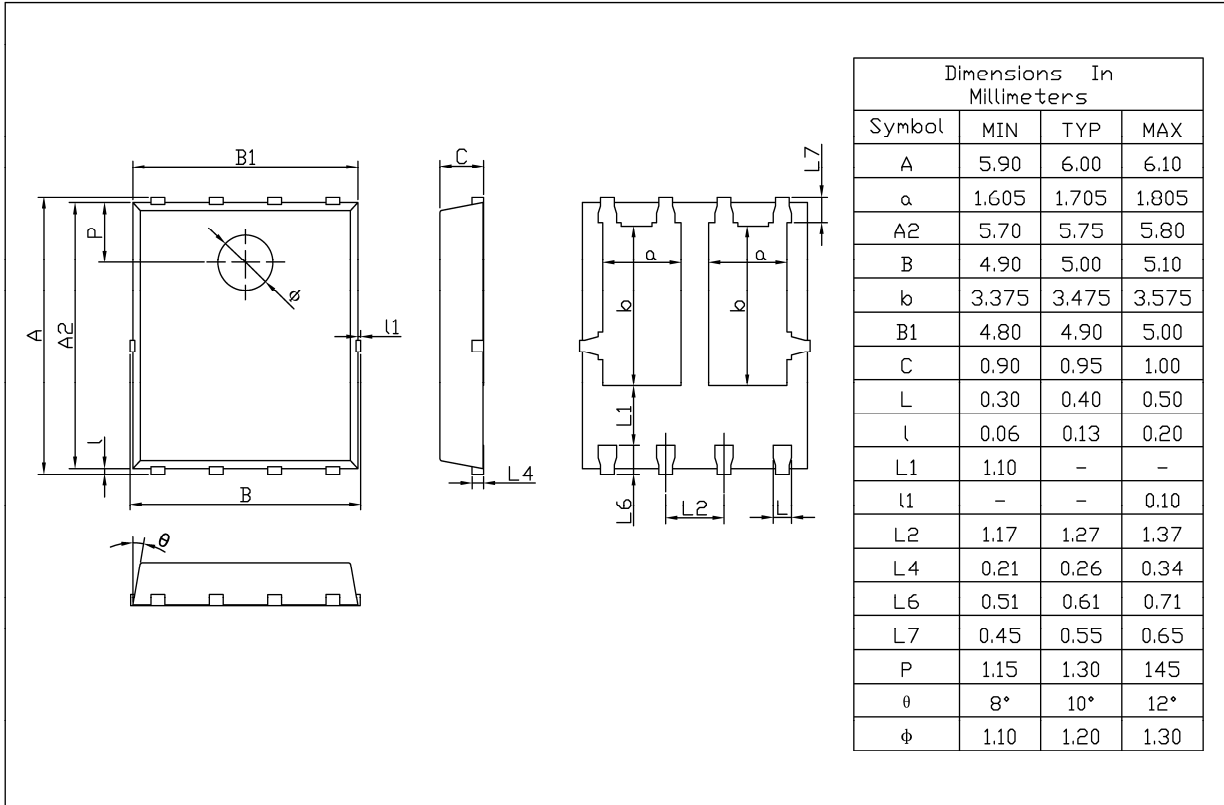

Figure 10: Normalized Maximum Transient Thermal Impedance

外形尺寸图 / Package Dimensions

PDFN5 X6A

Unit:mm



Rev.01 202209

印章说明 / Marking Instructions

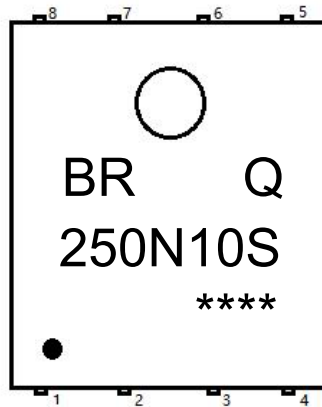

说明：

BR： 为公司代码

Q： 为汽车无卤产品标识

250N10S： 为型号代码

****： 为生产批号代码，随生产批号变化

Note：

BR： Company Code

Q: Automobile halogen-free product Code

250N10S： Product Type Code

****: Lot No. Code, code change with Lot No

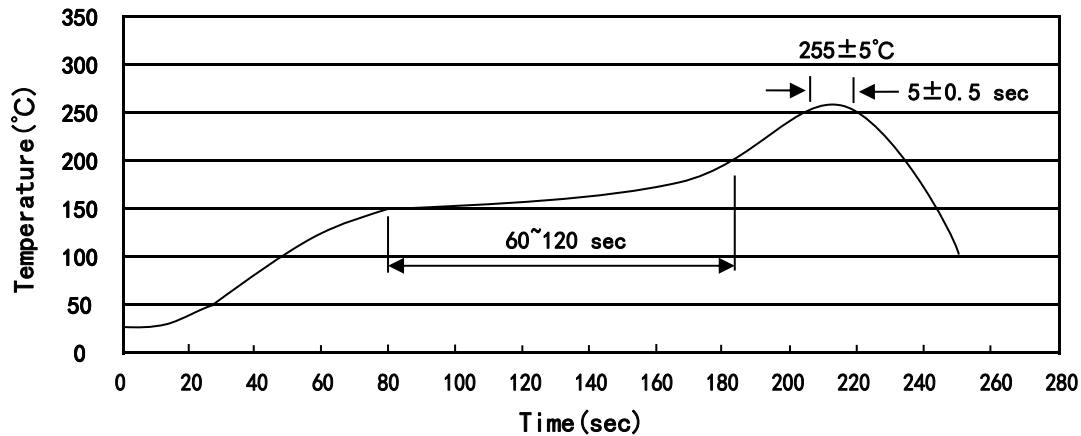
回流焊温度曲线图(无铅) / Temperature Profile for IR Reflow Soldering(Pb-Free)

说明：

- 1、预热温度 150~200°C，时间 60~120sec;
- 2、峰值温度 255±5°C，时间持续为 5±0.5sec;
- 3、焊接制程冷却速度为 2~10°C/sec.

Note:

- 1.Preheating:150~200°C, Time:60~120sec.
- 2.Peak Temp.:255±5°C, Duration:5±0.5sec.
3. Cooling Speed: 2~10°C/sec.

耐焊接热试验条件 / Resistance to Soldering Heat Test Conditions

温度：260±5°C

时间：10±1 sec.

Temp.:260±5°C

Time:10±1 sec

包装规格 / Packaging SPEC.

卷盘包装 / REEL

Package Type 封装形式	Units 包装数量					Dimension 包装尺寸 (unit: mm ³)		
	Units/Reel 只/卷盘	Reels/Inner Box 卷盘/盒	Units/Inner Box 只/盒	Inner Boxes/Outer Box 盒/箱	Units/Outer Box 只/箱	Reel	Inner Box 盒	Outer Box 箱
PDFN5×6A	5,000	2	10,000	6	60,000	13"×12	360×360×50	380×335×366

使用说明 / Notices